

USGT 30/8 U-B4 Ultrasonic Fork Sensor

- Large linearized analog range
- Very high repeatability
- Web edge control also with transparent materials
- Insensitive to dirt

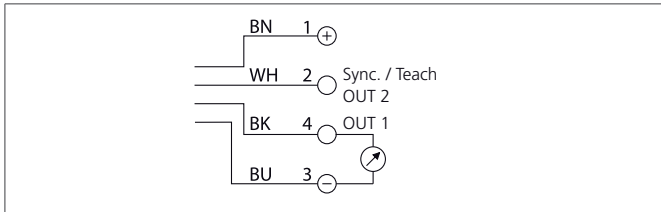

Safety instructions

The Instruments are not to be used for safety applications, in particular applications in which safety of persons depends on proper operation of the instruments.
These instruments shall exclusively be used by qualified personnel.

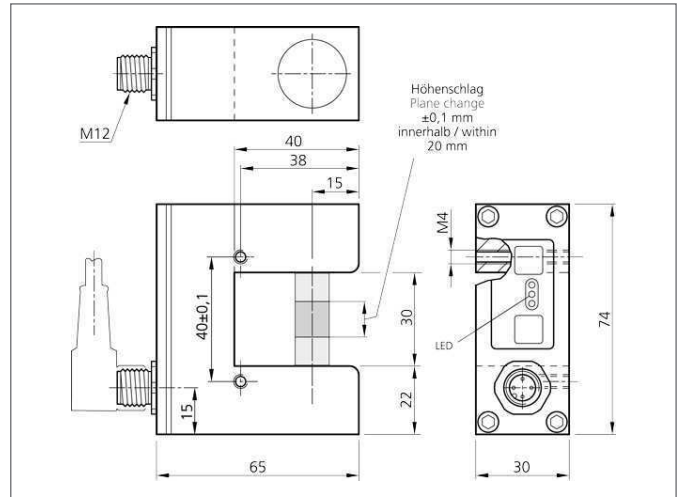

TECHNICAL INFORMATION (typ.)		+20°C, 24V DC
Operating principle		Ultrasonic through beam sensor
Evaluation		analog
Design		fork
Fork width/measuring range		30/8 mm
Service voltage		8 ... 30 V DC
Internal power consumption		35 mA
Sensitivity adjustment		Teach key
Analog output		10 ... 0 V, Load / < 10.000 Ω
Ripple		10 %
Switching frequency		500 Hz
Reproducibility		0,1 mm
Ambient temperature		0 ... +60 °C
Insulation voltage endurance		500 V
Protection class		IP 67
Casing material		Aluminium black anodized
Connection		Connector, M12, 4-poled